

**GENERAL PURPOSE TRANSISTORS**

**DESCRIPTION**

The BC140 and BC141 are silicon planar epitaxial NPN transistors in TO-39 metal case. They are particularly designed for audio amplifiers and switching applications up to 1 A. The complementary PNP types are the BC160 and BC161.

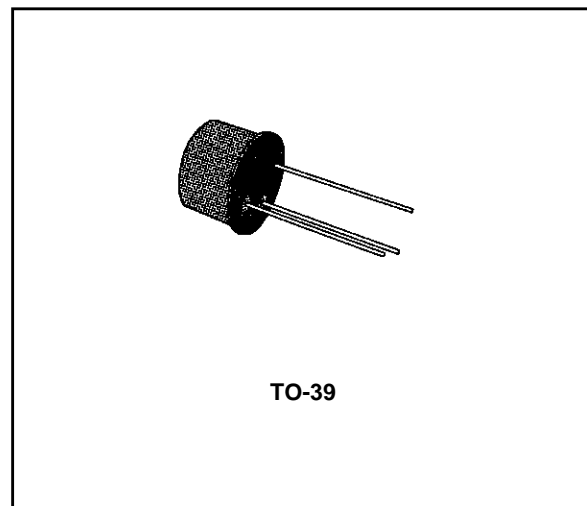

**INTERNAL SCHEMATIC DIAGRAM**

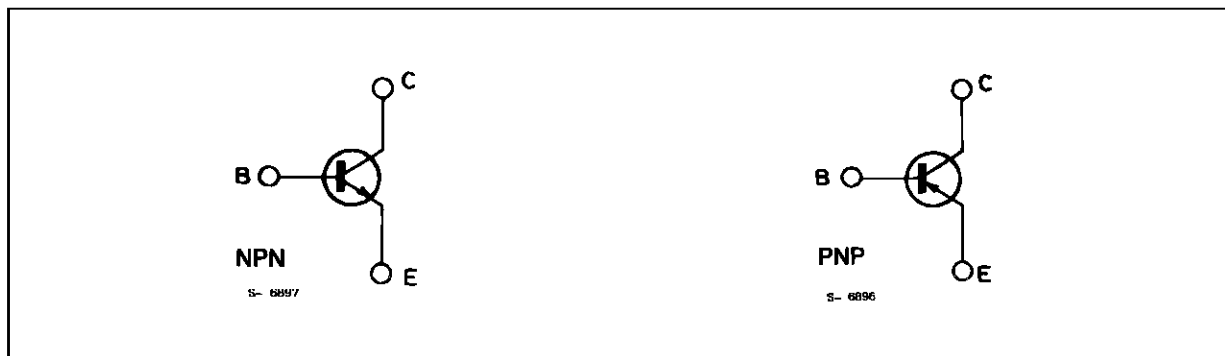

**ABSOLUTE MAXIMUM RATINGS**

Symbol	Parameter	Value		Unit
		BC140	BC141	
$V_{CBO}$	Collector-base Voltage ( $I_E = 0$ )	80	100	V
$V_{CEO}$	Collector-emitter Voltage ( $I_B = 0$ )	40	60	V
$V_{EBO}$	Emitter-base Voltage ( $I_C = 0$ )	7		V
$I_C$	Collector Current	1		A
$I_B$	Base Current	0.1		A
$P_{tot}$	Total Power Dissipation at $T_{amb} \leq 45\text{ }^\circ\text{C}$ at $T_{case} \leq 45\text{ }^\circ\text{C}$	0.65		W
		3.7		W
$T_{stg}$	Storage Temperature	- 55 to 175		$^\circ\text{C}$
$T_j$	Junction Temperature	175		$^\circ\text{C}$

## BC140-BC141

### THERMAL DATA

$R_{th\ j-case}$	Thermal Resistance Junction-case	Max	35	°C/W
$R_{th\ j-amb}$	Thermal Resistance Junction-ambient	Max	200	°C/W

### ELECTRICAL CHARACTERISTICS ( $T_{amb} = 25\text{ °C}$ unless otherwise specified)

Symbol	Parameter	Test Conditions	Min.	Typ.	Max.	Unit
$I_{CES}$	Collector Cutoff Current ( $I_E = 0$ )	$V_{CES} = 60\text{ V}$ $V_{CES} = 60\text{ V}$ $T_{amb} = 150\text{ °C}$			100 100	nA $\mu\text{A}$
$V_{(BR)CBO}$	Collector-base Breakdown Voltage ( $I_E = 0$ )	$I_C = 100\text{ }\mu\text{A}$ for <b>BC140</b> for <b>BC141</b>	80 100			V V
$V_{(BR)CEO}^*$	Collector-emitter Breakdown Voltage ( $I_B = 0$ )	$I_C = 30\text{ mA}$ for <b>BC140</b> for <b>BC141</b>	40 60			V V
$V_{(BR)EBO}$	Emitter-base Breakdown Voltage ( $I_C = 0$ )	$I_E = 100\text{ }\mu\text{A}$	7			V
$V_{CE(sat)}^*$	Collector-emitter Saturation Voltage	$I_C = 100\text{ mA}$ $I_B = 10\text{ mA}$ $I_C = 500\text{ mA}$ $I_B = 50\text{ mA}$ $I_C = 1\text{ A}$ $I_B = 0.1\text{ A}$		0.1 0.35 0.6	1	V V V
$V_{BE}^*$	Base-emitter Voltage	$I_C = 1\text{ A}$ $V_{CE} = 1\text{ V}$		1.25	1.8	V
$h_{FE}^*$	DC Current Gain	$I_C = 100\text{ }\mu\text{A}$ $V_{CE} = 1\text{ V}$ for <b>BC140-141</b> for <b>BC140-141</b> Gr. 6 for <b>BC140-141</b> Gr. 10 for <b>BC140-141</b> Gr. 16 $I_C = 100\text{ mA}$ $V_{CE} = 1\text{ V}$ for <b>BC140-141</b> for <b>BC140-141</b> Gr. 6 for <b>BC140-141</b> Gr.10 for <b>BC140-141</b> Gr.16 $I_C = 1\text{ A}$ $V_{CE} = 1\text{ V}$ for <b>BC140-141</b> for <b>BC140-141</b> Gr. 6 for <b>BC140-141</b> Gr.10 for <b>BC140-141</b> Gr.16		75 28 40 90 40 40 63 100 100 26 15 20 30	250 100 160 250	
$f_T$	Transition Frequency	$I_C = 50\text{ mA}$ $V_{CE} = 10\text{ V}$	50			MHz
$C_{CBO}$	Collector-base Capacitance	$I_E = 0$ $V_{CB} = 10\text{ V}$ $f = 1\text{ MHz}$		12	25	pF
$t_{on}$	Turn-on Time	$I_C = 100\text{ mA}$ $I_{B1} = 5\text{ mA}$			250	ns
$t_{off}$	Turn-off Time	$I_C = 100\text{ mA}$ $I_{B1} = I_{B2} = 5\text{ mA}$			850	ns

\* Pused : pulse duration = 300  $\mu\text{s}$ , duty cycle = 1 %.

Collector-emitter Saturation Voltage.

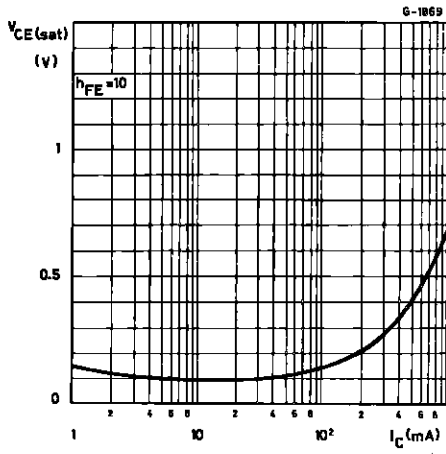

Base-emitter Voltage.

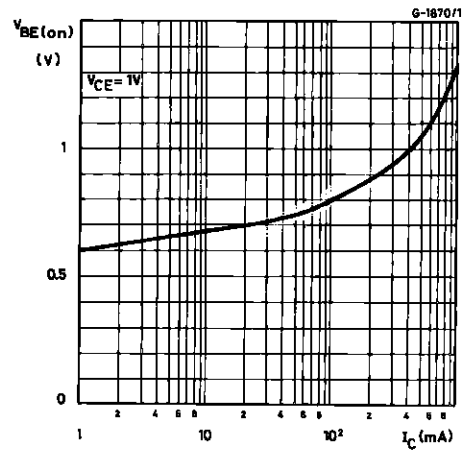

DC Current Gain.

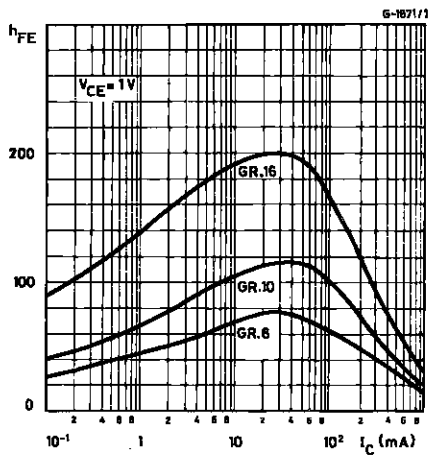

Transition Frequency.

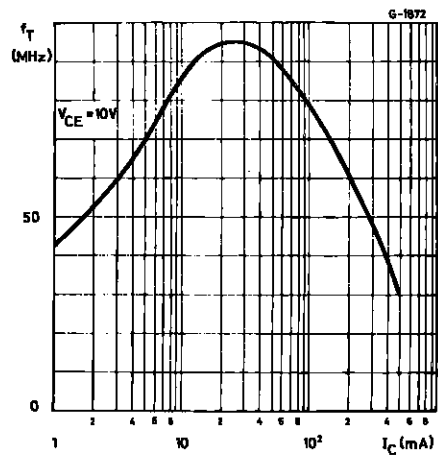

**TO39 MECHANICAL DATA**

DIM.	mm			inch		
	MIN.	TYP.	MAX.	MIN.	TYP.	MAX.
A	12.7			0.500		
B			0.49			0.019
D			6.6			0.260
E			8.5			0.334
F			9.4			0.370
G	5.08			0.200		
H			1.2			0.047
I			0.9			0.035
L	45° (typ.)					

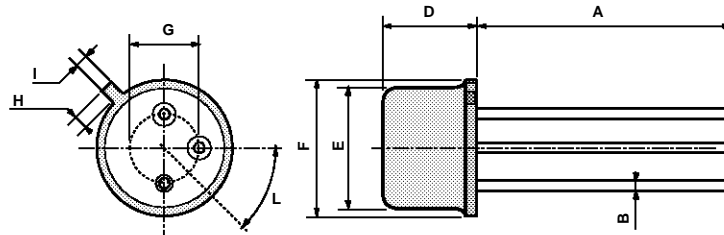

P008B

Information furnished is believed to be accurate and reliable. However, SGS-THOMSON Microelectronics assumes no responsibility for the consequences of use of such information nor for any infringement of patents or other rights of third parties which may result from its use. No license is granted by implication or otherwise under any patent or patent rights of SGS-THOMSON Microelectronics. Specifications mentioned in this publication are subject to change without notice. This publication supersedes and replaces all information previously supplied. SGS-THOMSON Microelectronics products are not authorized for use as critical components in life support devices or systems without express written approval of SGS-THOMSON Microelectronics.

© 1994 SGS-THOMSON Microelectronics - All Rights Reserved

SGS-THOMSON Microelectronics GROUP OF COMPANIES

Australia - Brazil - France - Germany - Hong Kong - Italy - Japan - Korea - Malaysia - Malta - Morocco - The Netherlands -  
Singapore - Spain - Sweden - Switzerland - Taiwan - Thailand - United Kingdom - U.S.A